



## Operating Instructions

Hydro Shaking Water Baths  
H 20 S, H 20 SW, H 20 SOW







Control panel for setting and display of the temperature  
H 20 S, H 20 SW und H 20 SOW



Control panel for setting and display of the shaking frequency  
H 20 S



Control panel for setting and display of the shaking frequency  
H 20 SW und H 20 SOW

Before installation, please check whether contents of package are in good order and complete.

Should you note any damages or have any reasons for complaint, please contact your supplier or directly:

LAUDA DR. R. WOBSE R GMBH & CO. KG

Schulze-Delitzsch-Str. 4+5

30938 Burgwedel - Germany

Phone: +49 (0)5139 9958 0

Fax: +49 (0)5139 9958 21

Email: [info@lauda.de](mailto:info@lauda.de)

Internet: <https://www.lauda.de>

Translation of the original operating instructions

Q4DT-E\_13-004-EN-01, 03.07.2023

© 2023 LAUDA DR. R. WOBSE R GMBH & CO. KG



## Contents

Operating Instructions .....	1
1 Use of the Shaking Water Bath .....	7
1.1 Intended Use.....	7
1.2 Improper Use .....	7
2 Warranty conditions.....	7
3 Before installation .....	8
4 Location of the Shaking Water Bath .....	8
5 Voltage .....	8
6 Filling water into the Shaking Water Bath .....	9
7 Special Accessory Level Regulator .....	9
8 Starting Operation .....	10
8.1 Setting the temperature of the temperature controller.....	10
8.2 Adjusting the frequency (speed) of the shaker drive.....	10
9 Cooling Coil (only Shaking Water Bath H 20 SW, H 20 SOW).....	11
10 Maintenance and Support .....	11
10.1 Monitoring of the temperature regulator .....	12
10.2 Low water cut-off.....	12
10.3 Shutdown caused by overload or power failure .....	12
10.4 Servicing and maintenance .....	13
10.5 Technical support.....	13
11 Disposal of Old Appliances .....	13
12 Technical Data .....	14
13 Circuit diagram.....	15
14 Examples for connection to the mains supply .....	16
14.1 Electrical fuses .....	16
14.2 Examples for connection to the mains .....	17
15 Accessories.....	18
16 Notes .....	20
17 Ordering spare parts / LAUDA Service .....	21
18 Product Returns and Clearance Declaration .....	22
19 EC Declaration of Conformity and certificates.....	23



## 1 Use of the Shaking Water Bath

### 1.1 Intended Use



LAUDA Hydro Shaking Water Baths are used to heat up tap water in a temperature range of approx. 5 K above ambient to 99,9 °C (models H 20 S, H 20 SW, H 20 SOW) for temperature-controlled warming of different media in laboratory vessels of different shapes.

The information contained in these operating instructions must by all means be read and observed. Only then can a perfect operation of the Shaking Water Bath be guaranteed. The units may only be installed and operated by persons who have made themselves familiar with these operating instructions.



CAUTION:

Hot surfaces at temperatures above 50 °C. Danger of burns, and danger of scaldings through steam released when opening the lid of the Shaking Water Bath. It is recommended to wear suitable safety gloves.



CAUTION:

Never grab into the moving device! Increased risk of injury! Uncontrolled closing of the Shaking Water Bath lid carries a high risk of injury. Protect yourself by working carefully on Shaking Water Baths with open lid.

### 1.2 Improper Use

Use the Shaking Water Bath with tap water only. Other media, e. g. oils or acids, will lead to damages and, possibly, total unit failure. Neither aggressive nor corrosive waters may be used as a thermostating liquid. The Shaking Water Bath may not be used in laboratory areas with aggressive or corrosive ambient conditions. It is not permissible to heat up or vaporise aggressive media, e. g. hydrochloric acid, in the unit itself or in its vicinity. The temperature work must not create an explosive atmosphere in the vicinity of the unit. The Shaking Water Bath may not be operated in potentially explosive surroundings. LAUDA Hydro Shaking Water Baths are not suitable for direct temperature work of foodstuffs, beverages and tobacco or for medical-technical and pharmaceutical products. Direct temperature work means unprotected contact of the substances with the Shaking Water Bath filling. LAUDA Hydro Shaking Water Baths, operated in a laboratory, are no Medical Devices. They neither fall under national nor international Medical Device Directives nor have to be used and applied accordingly.

## 2 Warranty conditions

LAUDA offers a standard 12 month manufacturer's warranty from the date of purchase.

### 3 Before installation

The information given in the present manual must by all means be carefully read and observed. Only then can a perfect functioning of the Shaking Water Bath be guaranteed.

Safety precautions are additionally marked with the following symbols



Read and observe the operating instructions



Warning of hot liquids and vapour



Warning of hot surfaces



Warning of hand injuries



Warning of dangerous electrical voltage



General warning

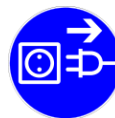

Before maintenance and repair disconnect the unit all-pole from the electrical mains (pull the plug from the socket).

### 4 Location of the Shaking Water Bath



Place on solid, even and level surfaces only. Do not use outside buildings. The unit is not suitable for use in explosion endangered surroundings, e. g. during anaesthesia with inflammable gas or steam types!

### 5 Voltage

Main switch and starter switch must be in OFF position.

Mains voltage and voltage stated on the name plate at the back of the unit must be identical.

If this applies, unit can be connected.



The Shaking Water Bath must only be connected to a correctly installed shock proof power socket. Maximum line impedance  $Z_{max} = 0,135 \text{ Ohm}$ . When required this value has to be asked at the responsible energy supply company.



## 6 Filling water into the Shaking Water Bath



Use the Shaking Water Bath only with tap water. Even stainless steel will corrode when used improperly. Use neither ferruginous nor chlorous water, in order to prevent rust formation and pitting. Using distilled or deionised water will also ultimately lead to corrosion in the Shaking Water Bath and must, therefore, be avoided.

Other media, such as oil, acid, or other additives, not approved by LAUDA, to prevent bacteria contamination (chlorine or copper sulphate), may lead to damages to the Shaking Water Bath basin, the screw connections of the ducts and the heating element.

Before operation, the Shaking Water Bath interior must be filled with water. Do make sure that the water outlet tap at the back of the unit is closed (handle must have a 90 ° angle from tap position). Open the lid and fill the Shaking Water Bath. The water level should be kept between the "min" and "max" markings.

## 7 Special Accessory Level Regulator

With the adjustable level regulator at the back of the unit, occurring water loss (through evaporation) is compensated and thus water level is kept constant. The level regulator also allows operation of the Shaking Water Bath below room ambient, minimum of approx. 3°C above tap water temperature. Before operation, the level regulator must be connected to water tap.

The upper hose connection of the switch is the water supply. Connect this to the tap by means of a laboratory hose (inside diameter max. 9 mm). The lower hose connection is for water outlet and must be connected to a lower placed drain (outlet descendent) by a hose as described above. Please ensure a free flow for this outlet without the possibility of backflow!

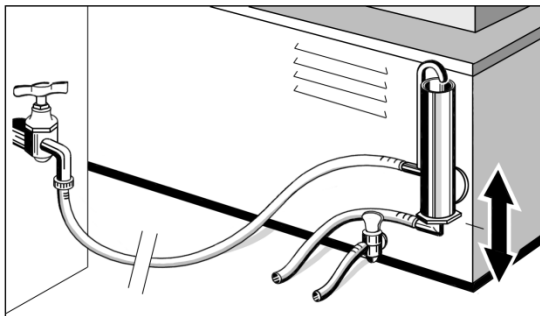

All hose connections must be secured with hose clamps. The desired water level can be adjusted by the outlet tube of the level regulator. For this purpose please loosen the outlet tube screwing with a spanner GW 27. The water level can now be set by pulling out or pushing in the tube. Tighten screwing again. Now carefully open water tap and fill Shaking Water Bath with water as described in chapter 6.

## 8 Starting Operation

Switch on main switch. The green pilot lamp will glow.



CAUTION:

Hot surfaces when temperatures rise above 60 °C - danger of burns, and, when opening the lid of the Shaking Water Bath, danger of scaldings due to escaping steam. Wearing safety gloves strongly recommended.



CAUTION:

Under no circumstances grab into the moving device! Increased risk of injury! Uncontrolled closing of the Shaking Water Bath lid carries a high risk of injury, too! Protect yourself by working carefully on Shaking Water Baths with open lid.

### 8.1 Setting the temperature of the temperature controller

After switching on the Shaking Water Bath, the display shows the actual inside temperature. By pressing key "°C", the display will show the last set and registered temperature that will now be used again automatically. The temperature range is between approx. 5 K above ambient to 99.9 °C, temperature constancy (temporal) approx. +/- 0.1 K. The set temperature can be changed with keys "°C", "+" and/or "-". By pressing key "°C", the display switches from actual to set temperature. By pressing key "°C" and either "+" or "-" simultaneously (two finger operation), the desired temperature can be set in 0.1 K steps. The counting speed increases after a short time. The newly set temperature is saved as soon as key "°C" is released. The display will now show the actual temperature again. The yellow pilot lamp next to the temperature display shows that heating is in operation.

### 8.2 Adjusting the frequency (speed) of the shaker drive



The shaking device is operated by the switch in the starter panel. The shaking frequency (reciprocating) can be increased by turning the relevant knob clockwise. It can be set in a range of 10 to 250 min<sup>-1</sup>. Shaking Water Bath H 20 SW und H 20 SOW disposes of an LED display for the actual shaking frequency.

## 9 Cooling Coil (only Shaking Water Bath H 20 SW, H 20 SOW)

The standard cooling coil, suitable for connection to water taps or usual external cooling appliances, extends the unit's temperature range (lowest possible operation temperature: +10 °C). The cooling coil connection is situated at the back of the unit. Hoses of an internal diameter of approx. 6 mm can be pushed onto the cooling coil connection tube – hoses must be secured with hose clamps.

## 10 Maintenance and Support

LAUDA Hydro Shaking Water Baths are made from high-quality materials and are made to withstand even rough service conditions. Nevertheless, the units should only be subjected to rough conditions within sensible limits.



CAUTION: Prior to maintenance and cleaning let the Shaking Water Bath cool down! If required, the water in the Shaking Water Bath can be drained through the drain cock at the back of the Shaking Water Bath.

CAUTION: Danger of burns!

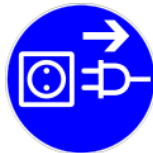

Make sure to prevent liquids coming into contact with cable connections or the inside of the electrical appliance. Except when descaling the unit disconnect the unit from the mains by pulling the plug, thus separating the Shaking Water Bath all-pole from the mains. Repairs of the electrical system may only be carried out by a trained electrician.

For cleaning purposes, the shaking device can be taken out of the Shaking Water Bath. For this purpose, the device has to be pushed to the max right and unscrewed via the knurled screw (connection to motor, Pos. 4 in the exploded view). The device can now be pushed to the far left and carefully lifted out of the Shaking Water Bath.

The inside bath can be descaled with suitable descaling agents (e. g. rea-calc® of M/s CHEMOTEC GmbH, 63486 Bruchköbel, Germany).

Do not use any hydrochloride acid product!

These products damage the unit's interior and screwings!

The polished exterior of the unit can easily be kept and restored with usual stainless steel polishing solutions (e. g. "Helios" by Messrs. Henkel Hygiene GmbH, 40589 Düsseldorf, Germany). The off-white powder coated parts can be cleaned with mild detergents if necessary.

It is advisable to regularly exchange the water within the Shaking Water Bath. The water outlet tap is situated at the back of the unit.

The Shaking Water Bath was set and calibrated at a temperature of 50 °C. For re-calibration during servicing, a calibration manual can be obtained from LAUDA Service (see on chapter 17) on request. Please enquire mention type and serial number of the unit in question.

Servicings, repairs or modifications must be carried out according to the commonly recognised Technical Rules and Regulations by competent electricians only. Only original spare parts must be used. Always demand a detailed confirmation of the carried out tasks by the person in charge (company, date, signature).

## 10.1 Monitoring of the temperature regulator

The temperature regulator disposes of electronic monitoring with error screening and con-current over-temperature cut-out. The Temperature Sensor of the regulator is constantly being screened for short circuits. In case of fault, display will show: "E1L" for a short circuit" in the Temperature Sensor or "E1H" for interruptions". The microprocessor controlled temperature regulator will switch off the heating circuit. After elimination of error, unit can be restarted. The unit also disposes of an electronic over-temperature cut-out for the protection of test substances, dependent on the set temperature. This device will switch off heating when the set temperature is exceeded by 4 °C. The electronic monitoring will induce the information "E2H" to be shown on the display. To restart heating, the unit must be switched off and then on again at the main switch. Should the information "E2H" remain, error must be attended by a competent electrician.

## 10.2 Low water cut-off

The Shaking Water Bath's heating element is protected against destruction by running dry by a low water cut-off (thermostatical over-temperature cut-out). In case of water shortage, power is cut. A nearly unvarying, realistic actual temperature is shown on the display of the temperature regulator, and the pilot lamps on the right side of the display and in the main switch will glow. Before restarting the unit, please fill Shaking Water Bath with water - as described in chapter 6 - and unlock low water cut-off. The unlocking device is situated at the back of the unit, below a black cap nut. Within the screwing, you will see a white plastic pin, which has to be gently pressed (e. g. with a pen) until a clicking sound can be heard.

## 10.3 Shutdown caused by overload or power failure

If the motor is over-heated due to overload, the shaking device will be switched off.

Caution, after the motor has cooled down and/or after a power failure, the shaking device restarts automatically. If the Shaking Water Bath is switched off due to a breakdown, the unit's main switch has to be switched off before the lid of the Shaking Water Bath is opened.

## 10.4 Servicing and maintenance

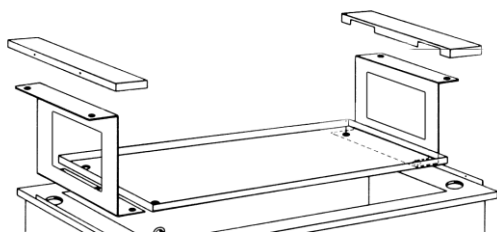

Scale deposits in the interior Shaking Water Bath can be removed with commercial descaling agents. Dismount the covers on the right and left of the Shaking Water Bath's lid and loosen the screw connections below the covers. The shaking tray seat can then easily be lifted out of the interior Shaking Water Bath. Do not use any hydrochloride acid products! These products damage the unit's interior and screw connections!

The polished exterior of the unit can easily be kept and restored with commercial stainless steel polishing solutions (e. g. "Helios" by M/s. Henkel Hygiene GmbH, 40589 Düsseldorf, Germany).

The off-white powder coated parts can be cleaned with mild detergents if necessary.

It is advisable to regularly exchange the water within the Shaking Water Bath. The water outlet tap is situated at the back of the unit.

## 10.5 Technical support

You can call our customer service at any time for technical support relating to LAUDA Hydro Shaking Water Baths appliances.

Phone : +49 (0) 9343 / 503-350

Fax : +49 (0)9343 503-283

Email : [service@lauda.de](mailto:service@lauda.de)

Maintenance, repairs and modifications must be carried out by a qualified electrician (section 2 (3) DGUV Regulation 3) according to the General Rules of Technology (section 2 (2) DGUV Regulation 3). Only original spare parts may be used. Request that the person performing the work provides written confirmation of the type and scope of the work carried out (company, date, signature).

## 11 Disposal of Old Appliances

LAUDA will take responsibility, within the scope of the legal directives, for an environmentally sound handling and disposal of all used LAUDA units as of the production year 1995 that are returned to us free of charge and will have it materially recycled. Before the unit is returned, a legally binding declaration must be provided from the sender confirming that the unit is free from harmful and/or hazardous contaminations as well as from hazardous substances caused by the previous use of the unit.

LAUDA laboratory apparatus are exclusively designed for industrial use and may not be disposed of through public waste disposal authorities

## 12 Technical Data

	H 20 S und H 20 SW	H 20 SOW
<b>Dimensions</b>		
Overall dimensions (W x D x H)	715 mm x 520 mm x 330 mm	635 mm x 505 mm x 400 mm
Inside dimensions (W x D x H)	450 mm x 300 mm x 160 mm	450 mm x 300 mm x 155 mm
Working height	190 mm (incl. lid height 30 mm)	190 mm (incl. lid height 35 mm)
	Reduced by approx. 15 mm when using Shaking Tray Typ A000023	
Max. water level above shaking device / shaking tray	105 mm / 90 mm	100 mm / 85 mm
<b>Temperature range</b>		
without level regulator	approx. 5 K above ambient to 99,9 °C	approx. 5 K above ambient to 80 °C
with level regulator	approx. 3 K above tap water temperature to 99,9 °C	approx. 3 K above tap water temperature to 80,0 °C
with cooling coil	+10 K to 99,9 °C (H 20 SW only)	+10 K to 80,0 °C
Temperature regulation	electronic, PI type	electronic, PI type
Temperature constancy	+/- 0,1 K (temporal)	+/- 0,1 K (temporal)
Temperature setting and display	digital -LED (0,1 K steps)	digital -LED (0,1 K steps)
<b>Over temperature protection</b>		
electronic	4 K above set temperature	4 K above set temperature
electro-mechanical	> 130 °C via low water cut-off	> 130 °C via low water cut-off
<b>Shaking motion</b>		
Shaking motion	reciprocating	orbital
Shaking frequency	10 - 250 min <sup>-1</sup>	depending on load 10 - 250 min <sup>-1</sup>
Shaking frequency display	digital -LED (1 min <sup>-1</sup> steps) only H 20 SW	digital -LED (1 min <sup>-1</sup> steps)
	Stroke length 22 mm	Shaking amplitude 14 mm
<b>Electrical connection</b>		
Voltage and frequency (Europe)	230 V +/- 10 %, 50 / 60 Hz	230 V +/- 10 %, 50 / 60 Hz
Voltage and frequency (USA)	115 V +/- 10 %, 60 Hz	115 V +/- 10 %, 60 Hz
Power	1500 W	1500 W
Power connection	Shock proof plug	Shock proof plug
Mains fuse, on-site	10 A at 230 V	10 A at 230 V
Protection type / class	I / IP20	I / covered (according to IP20)
<b>Ambient conditions</b>		
Surroundings	Only inside buildings (not in explosion endangered surroundings)	Only inside buildings
Height	up to 2000 m MSL	up to 2000 m MSL
Ambient temperature	+10 °C to +40 °C	+10 °C to +40 °C
Humidity	max. 80 % rel. humidity, up to 31°C; decreasing to 50% rel. humidity at 40°C	max. 80 % rel. humidity, up to 31°C; decreasing to 50% rel. humidity at 40°C
Weight	approx. 30 kg	approx. 35 kg

## 13 Circuit diagram

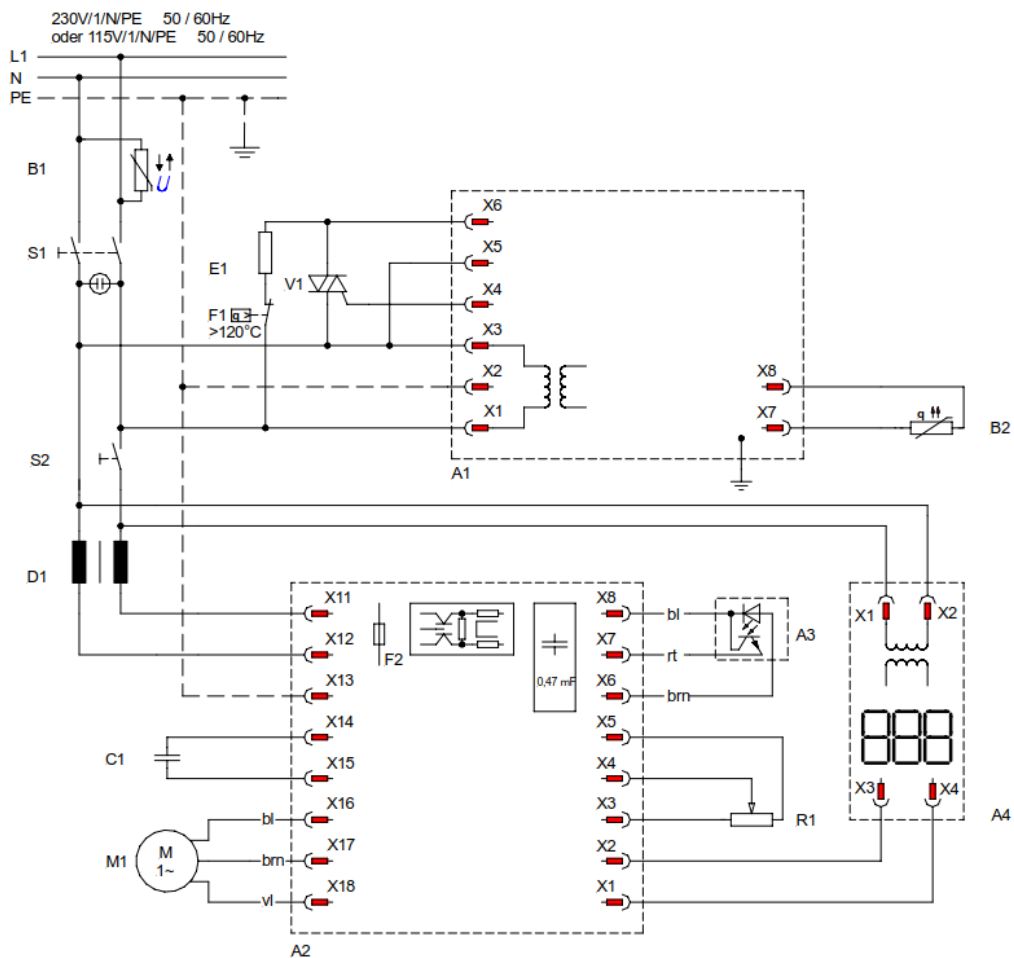

- A1 Electronic temperature regulator
- A2 Shaking frequency regulator
- A3 Pulse generator
- A4 Frequency display (H 20 SW and H 20 SOW)
- B1 Varistor
- B2 Temperature sensor
- C1 Capacitor
- D1 Choke
- E1 Heating element
- F1 Low water cut - off
- M1 Motor
- R1 Potentiometer
- S1 Main switch
- S2 Switch for motor
- V1 Triac

## 14 Examples for connection to the mains supply

The standard versions of LAUDA Hydro Shaking Water Baths models H 20 S, H 20 SW and H 20 SOW are supplied with a pre-assembled, cast-on shock-proof plug. Make sure to connect to a protective conductor terminal.

Colour coding of mains cable

ge/gr – yellow/green

bl – blue

sw – black

Mains supply

PE (Protective earth)

N

L1

All Shaking Water Baths supplied for 230 V (see information on the nameplate) can be connected to all power supplies of 220 V or 230 V. Maximum grid impedance  $Z_{max} = 0,135 \Omega$ . If necessary, this value should be requested from the responsible energy supply company.

### 14.1 Electrical fuses

Model	Power	Power consumption at mains voltage *	Mains fuse (F4, F5)
H 20 S, H 20 SW, H 20 SOW	1,5 kW	6,5 A at 230 V	10 A / Amp (max. 16 A / Amp.)

\* see nameplate



## 14.2 Examples for connection to the mains

### Components

- B1 Earthing contact socket (on-site)
- B2 Earthing contact plug (mounted on the unit)
- F4 Mains fuse (on-site)
- F5 Mains fuse (on-site)

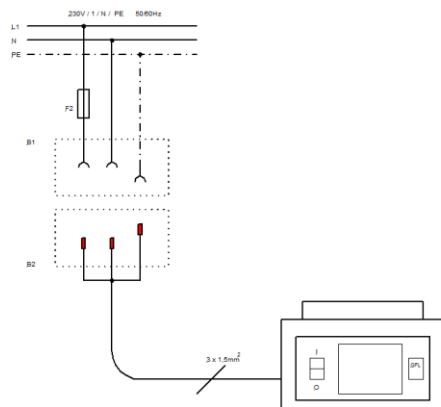

Models H 20 S, H 20 SW, H 20 SOW  
for 230 V with power  
supply 230 V / N / PE / 50/60 Hz,  
connected through 3-pole shock-proof  
(Schuko) plug system.

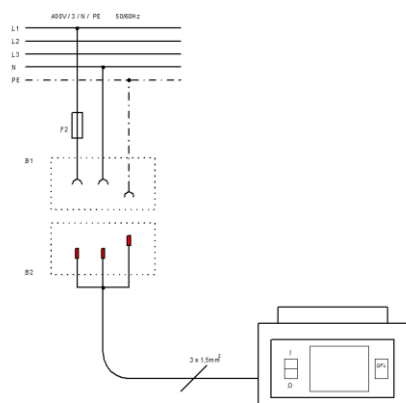

Models H 20 S, H 20 SW, H 20 SOW  
for 230 V with power  
supply 400 V / 3 / N / PE / 50/60 Hz,  
connected through 3-pole shock-proof  
(Schuko) plug system.

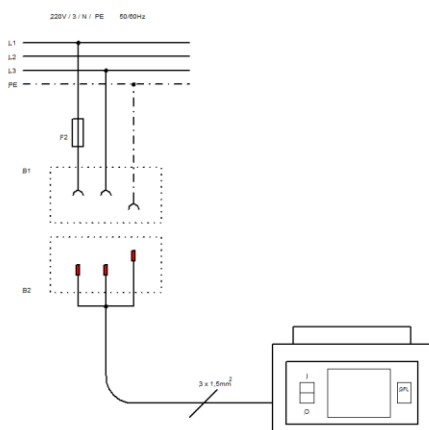

Models H 20 S, H 20 SW, H 20 SOW  
for 230 V with power  
supply 220 V / 3 / N / PE / 50/60 Hz,  
connected through 3-pole shock-proof  
(Schuko) plug system.

## 15 Accessories

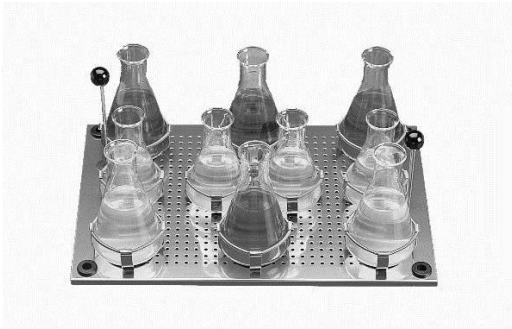

Shaking Tray made of stainless steel, perforated, to accommodate clamps for Erlenmeyer flasks of 25 ml to 500 ml. Equipped with two handles above water level for easy mounting and removal.

Order-no: A000023

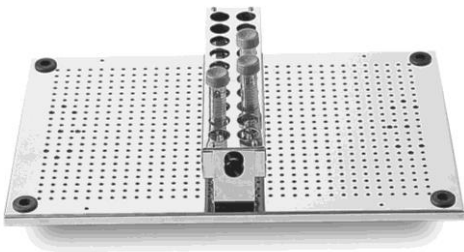

Test Tube Rack for example for Falcon tubes 15 ml, made of stainless steel. The holding device can be tilted by an angle of 90° and is equipped with springs for secure support. It can be screwed onto shaking tray A000023.

For max. 20 tubes Ø 12 – 17 mm. max. 4 racks per tray.

Order-no: A000032

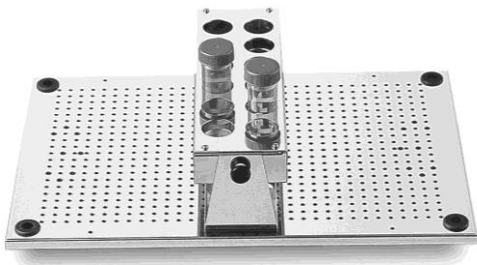

Test Tube Rack for example for Falcon tubes 50 ml, made of stainless steel. The holding device can be tilted by an angle of 90° and is equipped with springs for secure support. It can be screwed onto shaking tray A000023.

For max. 12 tubes Ø 25 – 29 mm, max. 3 racks per tray.

Order-no: A000033

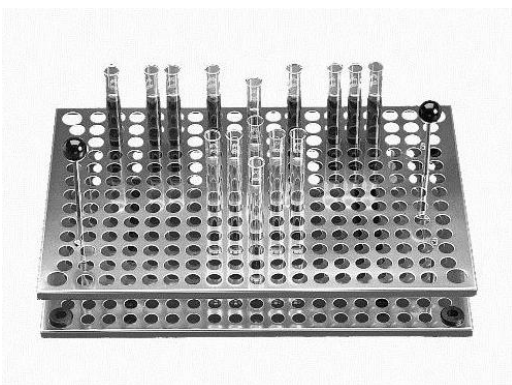

Test Tube Racks made of stainless steel, equipped with two handles above water level for easy mounting and removal.

Order-no: A000018

for max. 243 test tubes

Ø 16/17 mm

Order-no: A000019

for max. 63 test tubes

Ø 31 mm



Water level regulator for keeping water level constant and for cooling the Shaking Water Bath (also refer to item 7 Special Accessory Level Regulator). Adjustable, to be fixed to the back of the unit

Order-no: A000024

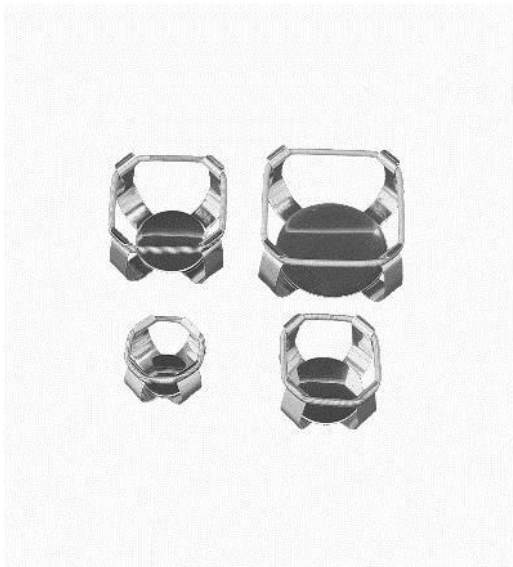

Flask clamps for Shaking Trays for Erlenmeyer Flasks, made of stainless steel, to be screwed onto Shaking Tray A000023, complete with screwing material.

\* = max. number of clamps per tray.

Order no: A000025	for	25 ml Erlenmeyer flasks (52*)
Order no: A000026	for	50 ml Erlenmeyer flasks (33*)
Order no: A000027	for	100ml Erlenmeyer flasks (22*)
Order no: A000028	for	200ml Erlenmeyer flasks (15*)
Order no: A000029	for	250-300ml Erlenmeyer flasks (13*)
Order no: A000030	for	500ml Erlenmeyer flasks (10*)
Order no: A000031	for	1000ml Erlenmeyer flasks ( 6*)



Raised lid for 1000 ml Erlenmeyer flasks (h = 220 mm), stainless steel

Order-no: A000038



## 17 Ordering spare parts / LAUDA Service

When ordering spare parts, please state the serial number (type plate) to avoid queries and wrong deliveries.

Your partner for maintenance and competent service support:

LAUDA Service  
Phone: +49 (0)9343 503-350  
Fax: +49 (0)9343 503-283  
Email: [service@lauda.de](mailto:service@lauda.de)

We are always at your disposal for questions and suggestions!

LAUDA DR. R. WOBSE GMBH & CO. KG  
Laudaplatz 1  
97922 Lauda-Königshofen  
Germany  
Phone: +49 (0)9343 503-0  
Fax: +49 (0)9343 503-222  
Email [info@lauda.de](mailto:info@lauda.de)  
Internet: <http://www.lauda.de/>

# 18 Product Returns and Clearance Declaration



## Product Returns and Clearance Declaration

### Product Returns

Would you like to return a LAUDA product you have purchased to LAUDA? For the return of goods, e.g. for repair or due to a complaint, you will need the approval of LAUDA in the form of a *Return Material Authorization (RMA)* or *processing number*. You can obtain the RMA number from our customer service department at +49 (0) 9343 503 350 or by email [service@lauda.de](mailto:service@lauda.de).

### Return address

LAUDA DR. R. WOBSEY GMBH & CO. KG  
Laudaplatz 1  
97922 Lauda-Königshofen  
Deutschland/Germany

Clearly label your shipment with the RMA number. Please also enclose this fully completed declaration.

RMA number	Product serial number
Customer/operator	Contact name
Contact email	Contact telephone
Zip code	Place
Street & house number	
Additional explanations	

### Clearance Declaration

The customer/operator hereby confirms that the product returned under the above-mentioned RMA number has been carefully emptied and cleaned, that any connections have been sealed to the farthest possible extent, and that there are no explosive, flammable, environmentally hazardous, biohazardous, toxic, radioactive or other hazardous substances in or on the product.

Place, date	Name in block letters	Signature



### EC DECLARATION OF CONFORMITY

**Manufacturer:** LAUDA DR. R. WOBSEY GMBH & CO. KG  
Schulze-Delitzsch-Straße 4+5, 30938 Burgwedel, Germany

We hereby declare under our sole responsibility that the machines described below

**Product Line:** Hydro **Serial number:** from 220\_\_\_\_\_

**Types:** H 4, H 8, H 8 A, H 16, H 16 A, H 22, H 24 and H 41  
H 20 S, H 20 SW and H 20 SOW  
H 5 V, H 6 V, H 9 V, H 11 V and H 19 V  
H 2 P

comply with all relevant provisions of the EC Directives listed below due to their design and type of construction in the version brought on the market by us:

Machinery Directive	2006/42/EC
EMC Directive	2014/30/EU
RoHS Directive	2011/65/EU in connection with (EU) 2015/863

The protective objectives of the Machinery Directive with regard to electrical safety are complied with in accordance with Annex I Paragraph 1.5.1 in conformity with the Low Voltage Directive 2014/35/EU.

Applied standards:

- EN 61326-1:2013
- EN 61010-1:2010/A1:2019/AC:2019-04
- EN IEC 61010-2-010:2020

Authorized representative for the composition of the technical documentation:

Dr. Jürgen Dirscherl, Head of Research & Development

Burgwedel, 05.06.2023

Dr. Alexander Dinger,  
Head of Quality and Environmental Management

LAUDA DR. R. WOBSEER GMBH & CO. KG

Schulze-Delitzsch-Straße 4+5 • 30938 Burgwedel • Germany

Phone.: +49 (0) 5139 9958-0 • Fax +49 (0) 5139 9958-21

Email: [info@lauda.de](mailto:info@lauda.de) • Internet: <https://www.lauda.de>